

R3C MALE HOUSING

R197.135._80

Series : **SMB**
CARLOCK

To obtain the complete P/N please fill in the blank "_" with the coding letter

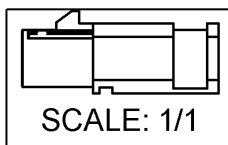
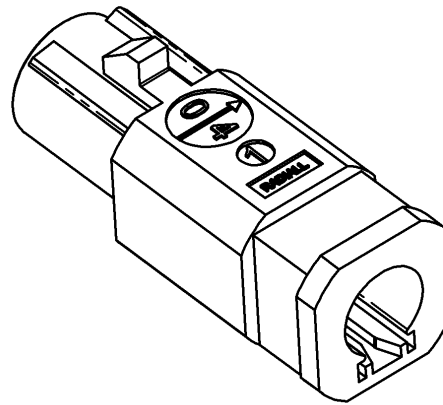
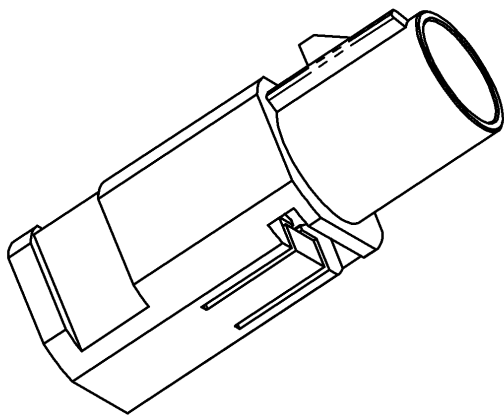
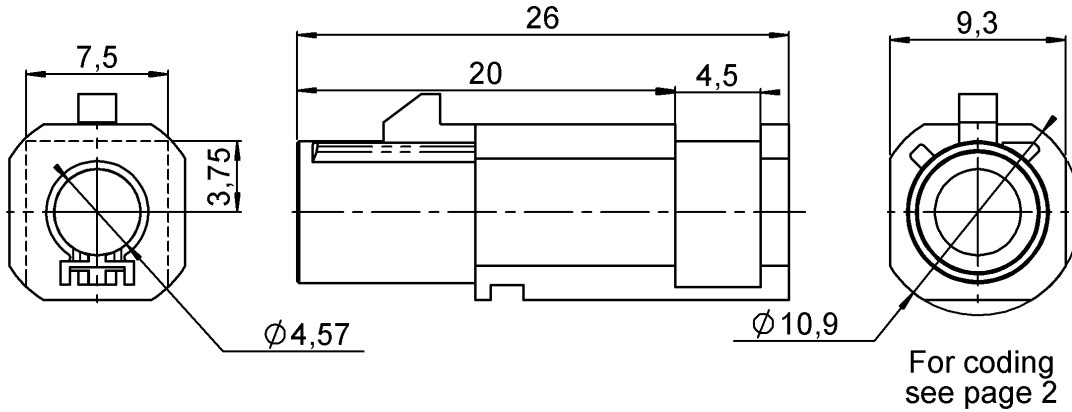

Housing to be used with:
-R299.197.000
-R299.197.010

All dimensions are in mm.

COMPONENTS	MATERIALS	PLATING (µm)	
		UL CLASSIFICATION	COLOR
HOUSING	PA6.6 GF15 (POLYAMIDE)	UL 94 V-2	See Page2

PACKAGING

Standard	Unit	Other
500	'W' option	Contact us

MECHANICAL CHARACTERISTICS

Mating life **100** Cycles mini
Weight **1,6500** g

ENVIRONMENTAL

Operating temperature **-40/+110** °C

Issue : 0745 A

In the effort to improve our products, we reserve the right to make changes judged to be necessary.



R3C MALE HOUSING

R197.135._80

Series : SMB
CARLOCK



CODING A
 COLOR BLACK
 RAL 9005



CODING B
 COLOR CREAMWHITE
 RAL 9001

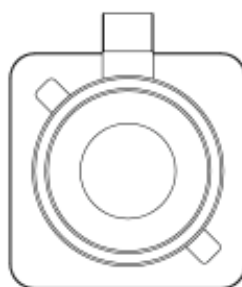

CODING C
 COLOR BLUE
 RAL 5005



CODING D
 COLOR BORDEAUX
 VIOLET
 RAL 4004

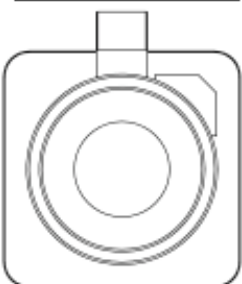

CODING E
 COLOR GREEN
 RAL 6002



CODING F
 COLOR BROWN
 RAL 8011

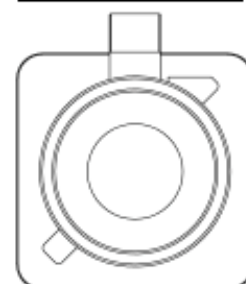

CODING G
 COLOR GREY
 RAL7031



CODING H
 COLOR VIOLET
 RAL 4003

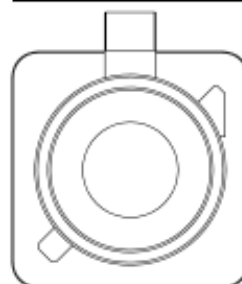

CODING I
 COLOR BEIGE
 RAL 1001

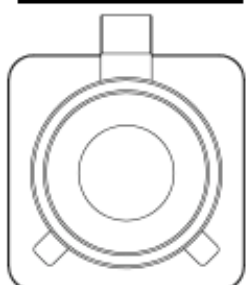

CODING K
 COLOR CURRY
 RAL 1027

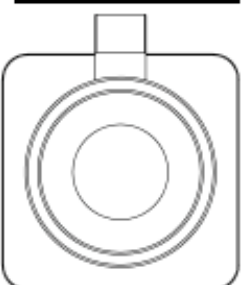

CODING Z
 COLOR WATER BLUE
 RAL 5021

UL CLASSIFICATION
 UL 94V-2

-To obtain the complete P/N please fill in the blank "_ " with the coding letter

Issue : 0745 A

In the effort to improve our products, we reserve the right to make changes judged to be necessary.



R3C MALE HOUSING

R197.135._80

Series : SMB
CARLOCK

RECOMMENDED MOUNTING PROCEDURE

1

● **Pre-insertion of the coax into the housing**

● **Orientation of the tab of the coax with the slot of the housing.**

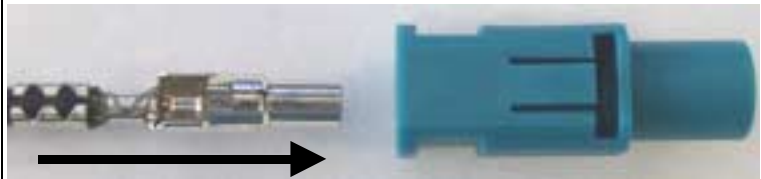

Orientation of the slot

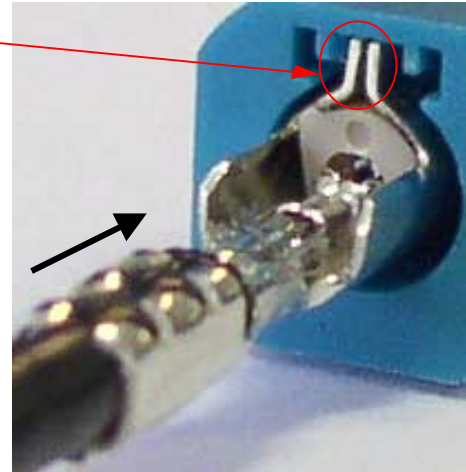

2

● **Push the connector into the housing until it clip on.**

● **Optional: verify if the coax is well mounted by rotating the housing.**

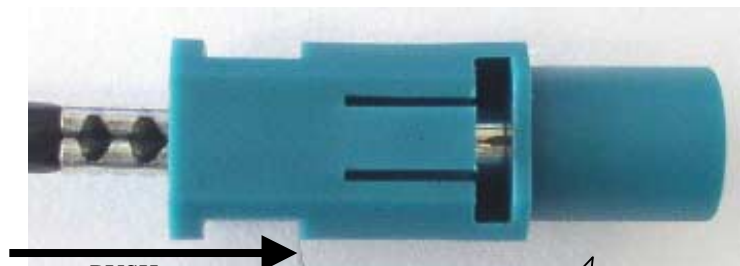

PUSH

click

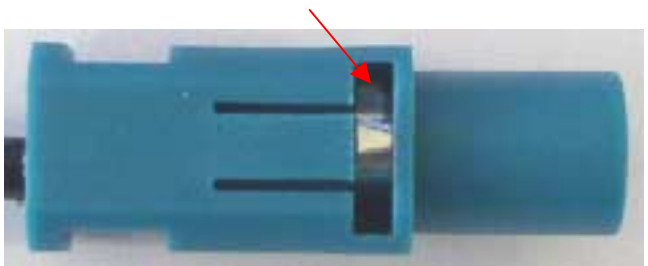
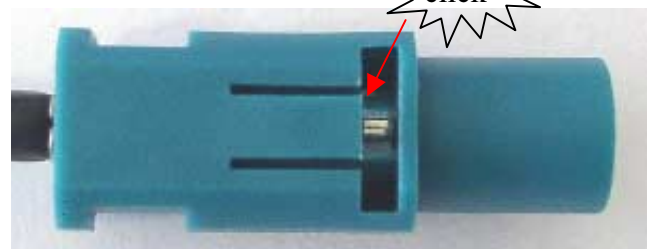

Issue : 0745 A

In the effort to improve our products, we reserve the right to make changes judged to be necessary.

R3C MALE HOUSING

R197.135._80

Series : SMB
CARLOCK

RECOMMENDED DISASSEMBLING PROCEDURE

1

- To unlock the coax from the housing, rotate the coax until the tab is not in front of the elastic finger of the housing.
- insert a screw driver between the elastic finger and the slot of the housing as shown on the picture.
- Tip down the screw driver as shown on the picture to lift up the elastic finger until you have enough room.

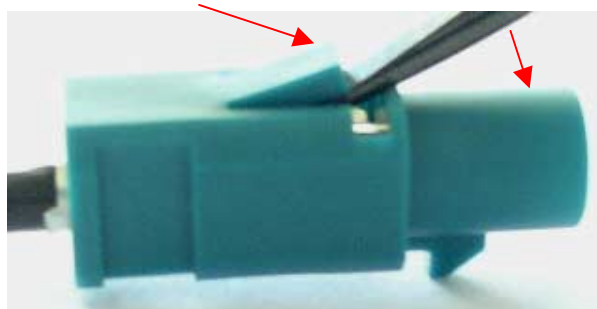
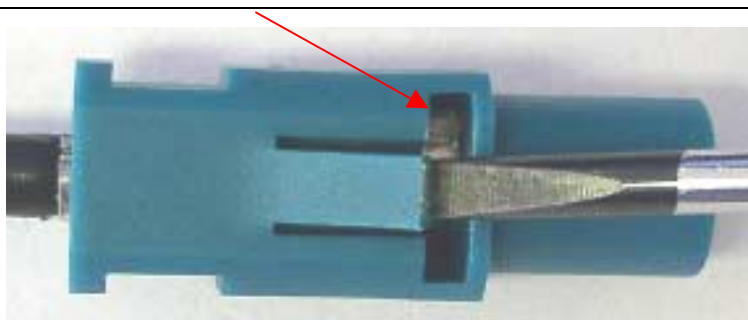

2

- Hold on the elastic finger up and rotate the coax until the tab is in front of the elastic finger of the housing. (you can use the crimping of the jacket as a reference).
- pull on the cable assembly to remove the coax from the housing.

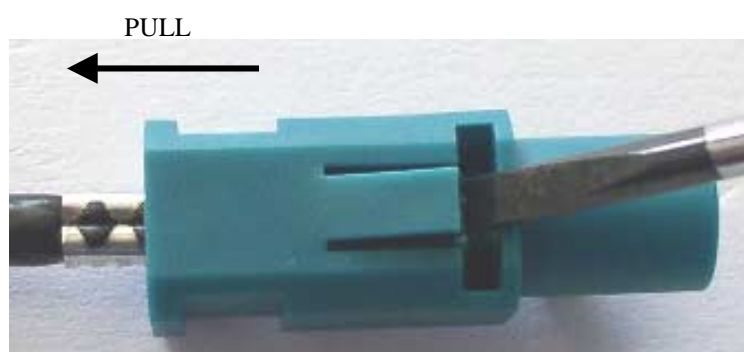

Issue : 0745 A

In the effort to improve our products, we reserve the right to make changes judged to be necessary.

